



Unione di Comuni Valdarno Valdisieve  
Comuni di Pontassieve Londa Pelago Rufina e San Godenzo



# Piano Strutturale Intercomunale

Sindaco del Comune di Pontassieve: **Monica Marini**  
Sindaco del Comune di Londa: **Tommaso Cuoretti**  
Sindaco del Comune di Pelago: **Nicola Povoleri**  
Sindaco del Comune di Rufina: **Vito Maida**  
Sindaco del Comune di San Godenzo: **Emanuele Piani**

RESPONSABILE DEL PROCEDIMENTO  
E COORDINATORE UFFICIO DI PIANO: **Fabio Carli**

GARANTE INFORMAZIONE  
E PARTECIPAZIONE: **Maddalena Rossi**

**UFFICIO UNICO DI PIANO:**

- Sonia Carletti** (Collaborazione al coordinamento dell'attività di pianificazione)
- Francesca Procacci** (Aspetti ambientali ed idrogeologici)
- Giorgio Volpi** (Progettazione db geografico del piano - elaborazioni GIS)
- Elisa Iannotta** (Analisi urbanistiche e territoriali - elaborazioni GIS)
- Caterina Fusi** (Editing ed elaborati grafici di sintesi - aspetti paesaggistici)
- Martina Angeletti** (Firenze Smart, aspetti urbanistici e paesaggistici - elaborazioni GIS)
- Paolo Biagiotti** (Firenze Smart, SIT)

**TECNICI REFERENTI COMUNI ASSOCIATI:**

- Silvia Rogai** (Comune di Pontassieve)
- Franco Pretolani** (Comuni di Londa e San Godenzo)
- Alessandro Pratesi** (Comune di Pelago)
- Pilade Pinzani** (Comune di Rufina)

**CONSULENTI ESTERNI:**

- Aspetti geologici: **Geo Eco Progetti**
- Aspetti idraulici: **Hydrogeo Ingegneria Srl**
- Aspetti agroforestali: **Ilaria Scatarzi**
- Aspetti faunistici: **Carlo Scoccianti**
- Revisione vincoli paesaggistici: **Francesca Furter**
- Aspetti socio economici: **PIN Srl**
- Processo partecipativo: **Maddalena Rossi**
- Valutazione Ambientale Strategica: **Ambiente Spa**
- Pubblicazione SIT: **Firenze Smart**



IL RESPONSABILE DEL PROCEDIMENTO  
(Dott. Fabio Carli)

**MODELLO IDRAULICO M14 - LIBRETTO SEZIONI CON LIVELLI IDROMETRICI TR 30-200 ANNI**

ADOZIONE

IDR\_M14\_02

APPROVAZIONE

Scala



## MODELLO M14 – CASTAGNO

Corsi d'Acqua:

- *Fosso dell'Acquatorta*
- *Fosso dell'Acquatorta – Affluente*
- *Torrente Le Prata*

FOSSO DELL'ACQUATORTA

Fosso dell' Acquatorta  
 SEZIONE N° 00217\_\_21

LEGENDA:

TR030 H = 776.25 m. s.l.m.

TR200 H = 776.38 m. s.l.m.

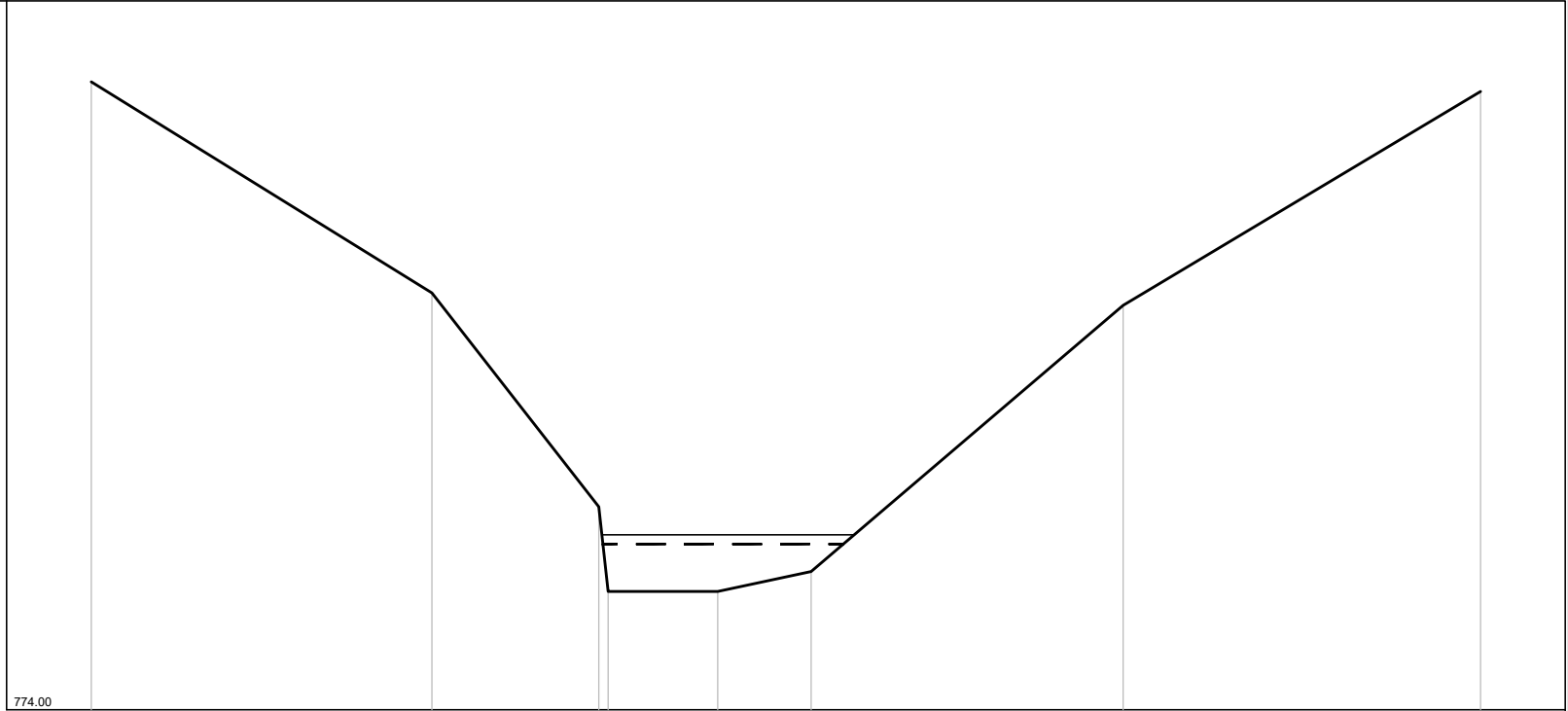

SCALA DISTANZE 1:100  
 SCALA QUOTE 1:100

774.00

PUNTI	1	2	3	4	5	6	7	8
QUOTE [m s.l.m.]	782.54	779.67	776.76 775.61	775.61	775.88	779.50	782.41	
DISTANZE PROGRESSIVE [m]	0.00	4.63	9.90 7.03	8.52	9.79	14.03	18.89	
DISTANZE PARZIALI [m]		4.63	2.27	1.49	1.27	4.24	4.86	

Fosso dell' Acquatorta  
 SEZIONE N° 00214PB21

LEGENDA:

TR030 H = 770.51 m. s.l.m. 

TR200 H = 771.00 m. s.l.m. 

SCALA DISTANZE 1:100  
 SCALA QUOTE 1:100

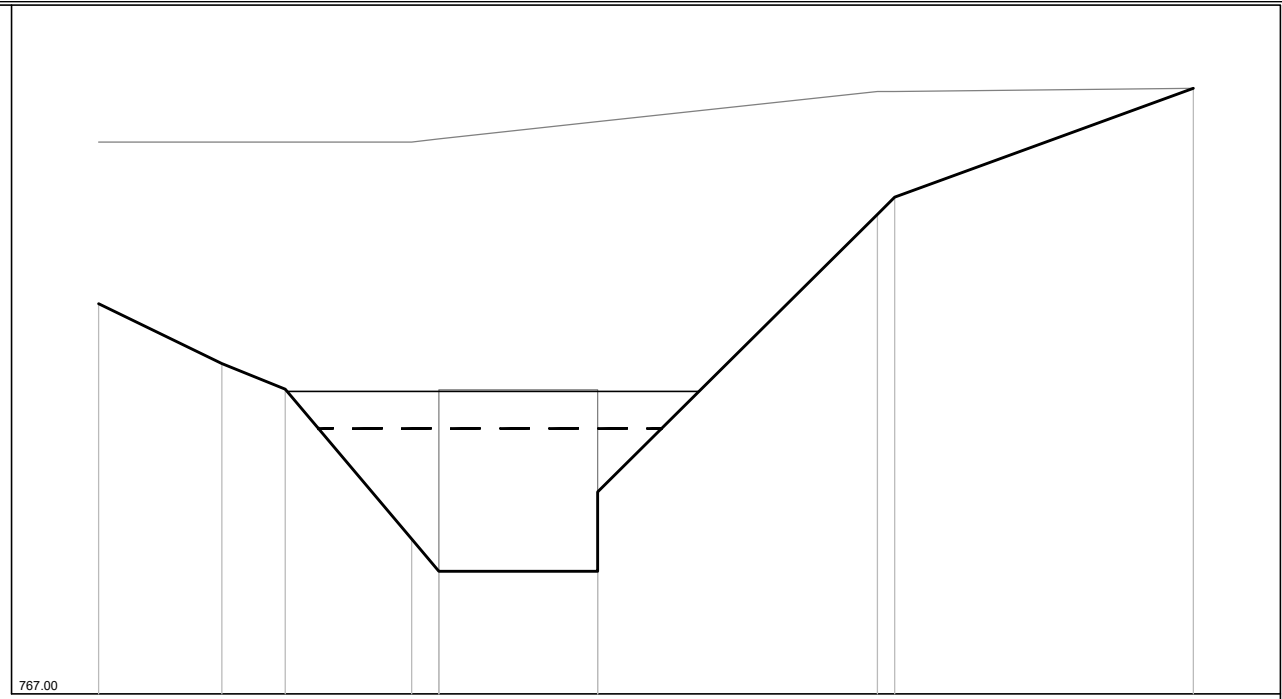

PUNTI	1	2	3	4	5	7	9	10	11
QUOTE [m s.l.m.]	772.16	771.37	771.03	769.05	768.62	768.62	773.34	773.57	775.01
DISTANZE PROGRESSIVE [m]	0.00	1.63	2.47	4.14	4.50	6.60	10.30	10.53	14.48
DISTANZE PARZIALI [m]		1.63	0.84	1.67		2.10	3.70		3.95

Fosso dell' Acquatorta  
 SEZIONE N° 00214PC21

LEGENDA:

TR030 H = 764.26 m. s.l.m. 

TR200 H = 764.37 m. s.l.m. 

SCALA DISTANZE 1:100  
 SCALA QUOTE 1:100

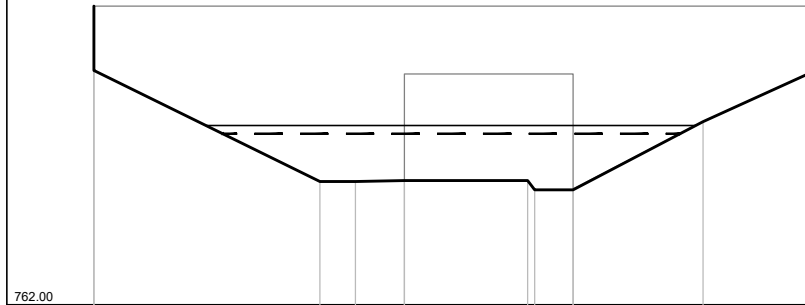

PUNTI	1	3	4	5	7	9	11	12
QUOTE [m s.l.m.]	765.95	763.63	763.63	763.64	763.64	763.52	764.42	765.10
DISTANZE PROGRESSIVE [m]	0.00	2.99	3.46	4.11	5.74	6.34	8.06	9.55
DISTANZE PARZIALI [m]		2.99	0.65	1.63	0.51	1.72	1.49	

Fosso dell' Acquatorta  
 SEZIONE N° 00211BB21

LEGENDA:

TR030 H = 764.10 m. s.l.m. 

TR200 H = 764.22 m. s.l.m. 

SCALA DISTANZE 1:100  
 SCALA QUOTE 1:100

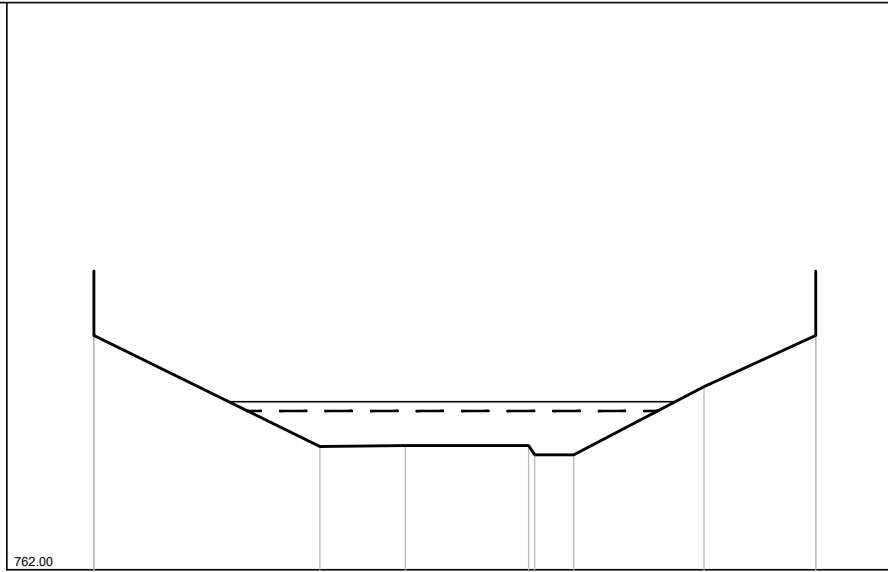

PUNTI	1	3	4	5	7	8	9
QUOTE [m s.l.m.]	765.95	763.63	763.64	763.64	763.52	764.42	765.10
DISTANZE PROGRESSIVE [m]	0.00	2.99	4.12	5.75	6.35	8.07	9.55
DISTANZE PARZIALI [m]		2.99	1.13	1.63	0.52	1.72	1.48

Fosso dell' Acquatorta  
 SEZIONE N° 00211BC21

LEGENDA:  
 TR030 H = 763.93 m. s.l.m. ---  
 TR200 H = 764.07 m. s.l.m. ———

SCALA DISTANZE 1:100  
 SCALA QUOTE 1:100

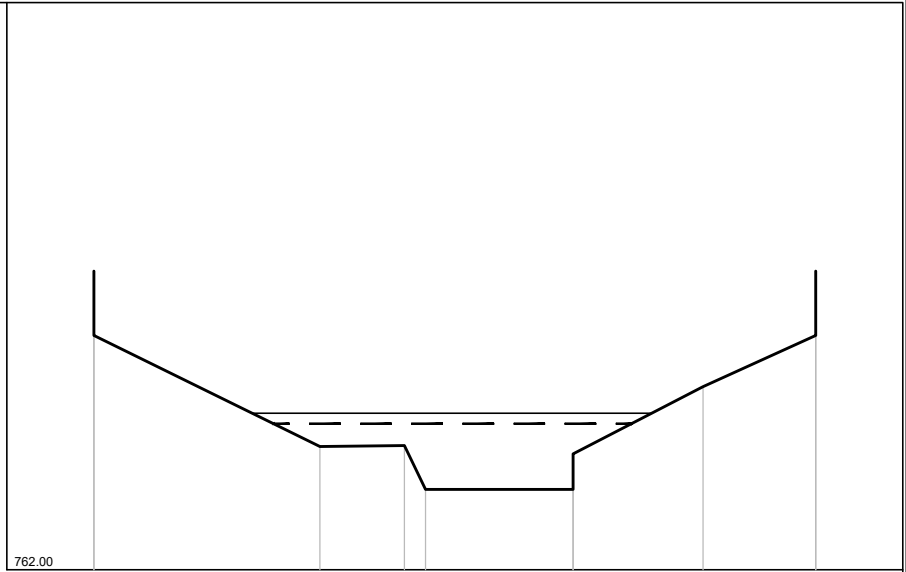

PUNTI	1	3	4	5	6	8	9
QUOTE [m s.l.m.]	765.95	763.63	763.64	763.06	763.06	764.42	765.10
DISTANZE PROGRESSIVE [m]	0.00	2.99	4.11	4.39	6.34	8.06	9.55
DISTANZE PARZIALI [m]		2.99	1.12		1.95	1.72	1.49



Fosso dell' Acquatorta  
 SEZIONE N° 00206\_\_21

LEGENDA:

TR030 H =758.60 m. s.l.m.

TR200 H =758.75 m. s.l.m.

SCALA DISTANZE 1:100  
 SCALA QUOTE 1:100

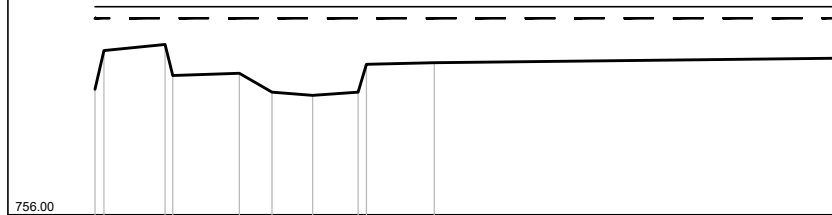

PUNTI	1	3	5	6	7	8	10	11
QUOTE [m s.l.m.]	757.86	758.25	757.87	757.62	757.58	757.62	758.01	758.07
DISTANZE PROGRESSIVE [m]	0.00	0.93	1.91	2.34	2.88	3.48	4.49	9.81
DISTANZE PARZIALI [m]		0.81	0.88	0.54	0.60	0.90	5.32	

Fosso dell' Acquatorta  
 SEZIONE N° 00200\_\_21

LEGENDA:

TR030 H=754.92 m. s.l.m. 

TR200 H=754.98 m. s.l.m. 

SCALA DISTANZE 1:100  
 SCALA QUOTE 1:100

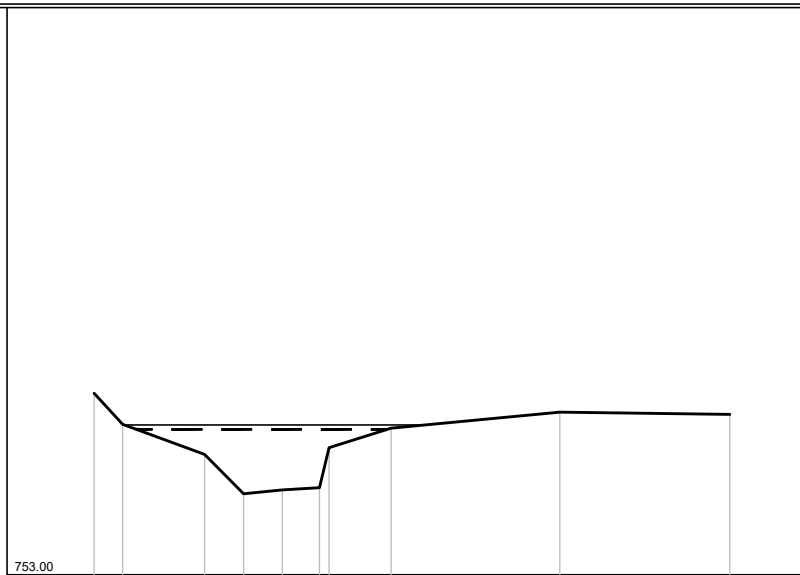

PUNTI	1	2	3	4	5	6	7	8	9	10
QUOTE [m s.l.m.]	755.40	754.99	754.69	754.07	754.12	754.15	754.88	754.94	755.15	755.12
DISTANZE PROGRESSIVE [m]	0.00	0.38	1.46	1.98	2.49	2.98	3.11	3.93	6.16	8.41
DISTANZE PARZIALI [m]		1.08	0.52	0.51	0.49	0.82	2.23	2.25		

Fosso dell' Acquatorta  
 SEZIONE N° 00199PB21

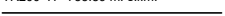
LEGENDA:  
 TR030 H = 753.68 m. s.l.m.   
 TR200 H = 753.89 m. s.l.m. 

SCALA DISTANZE 1:100  
 SCALA QUOTE 1:100

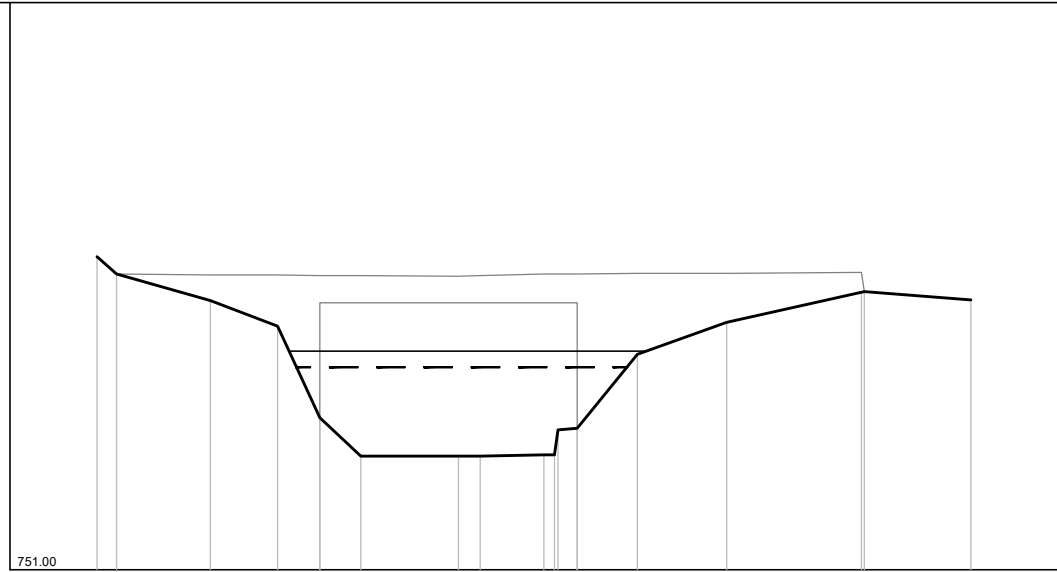

PUNTI	1	2	3	4	5	7	8	9	10	11	13	15	16	17	19
QUOTE [m s.l.m.]	755.14	754.91	754.96	754.22	753.01	752.50	752.50	752.50	752.52	752.82	752.87	753.85	754.27	754.67	754.57
DISTANZE PROGRESSIVE [m]	0.00	0.26	1.50	2.39	2.95	3.49	4.78	5.07	6.01	6.05	6.35	7.15	8.33	10.11	11.56
DISTANZE PARZIALI [m]		1.24	0.89	0.56	0.54	1.29		0.84			0.80	1.18	1.78		1.41

Fosso dell' Acquatorta  
 SEZIONE N° 00199PC21

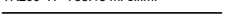
LEGENDA:  
 TR030 H = 753.08 m. s.l.m.   
 TR200 H = 753.18 m. s.l.m. 

SCALA DISTANZE 1:100  
 SCALA QUOTE 1:100

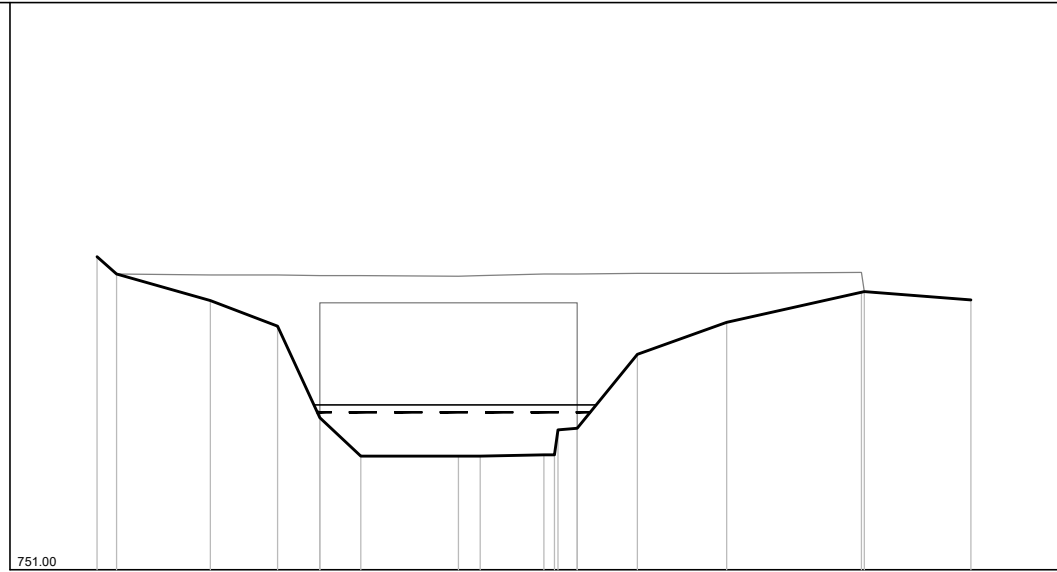

PUNTI	1	2	3	4	5	7	8	9	10	11	13	15	16	17	19
QUOTE [m s.l.m.]	755.14	754.91	754.96	754.22	753.01	752.50	752.50	752.50	752.52	752.82	752.87	753.85	754.27	754.67	754.57
DISTANZE PROGRESSIVE [m]	0.00	0.26	1.50	2.39	2.95	3.49	4.78	5.07	6.01	6.05	6.35	7.15	8.33	10.11	11.56
DISTANZE PARZIALI [m]		1.24	0.89	0.56	0.54	1.29		0.84			0.80	1.18	1.78		1.41

Fosso dell' Acquatorta  
 SEZIONE N° 00189BB21

LEGENDA:

TR030 H =745.70 m. s.l.m.  
 ---  
 TR200 H =745.88 m. s.l.m.  
 \_\_\_\_\_

SCALA DISTANZE 1:100  
 SCALA QUOTE 1:100

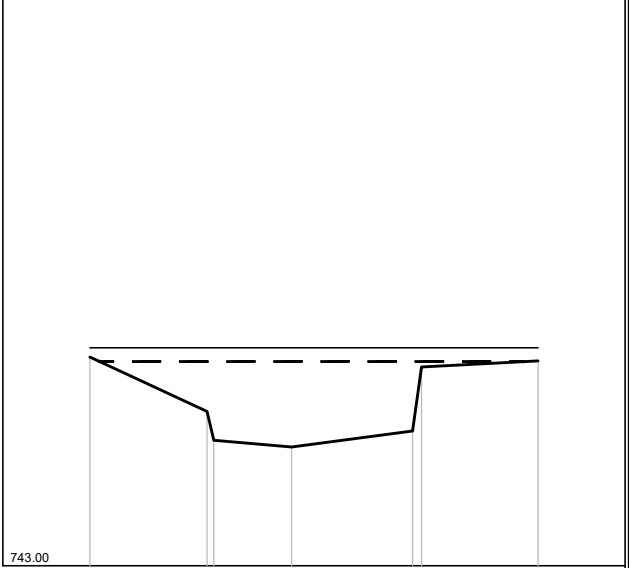

PUNTI	1	2	4	5	7
QUOTE [m s.l.m.]	745.76	745.04	744.57	744.78	745.71
DISTANZE PROGRESSIVE [m]	0.00	1.55	2.67	4.27	5.83
DISTANZE PARZIALI [m]		1.55	1.03	1.60	1.54

Fosso dell' Acquatorta  
 SEZIONE N° 00189BC21

LEGENDA:

TR030 H =745.33 m. s.l.m.  
 ---  
 TR200 H =745.55 m. s.l.m.  
 \_\_\_\_\_

SCALA DISTANZE 1:100  
 SCALA QUOTE 1:100

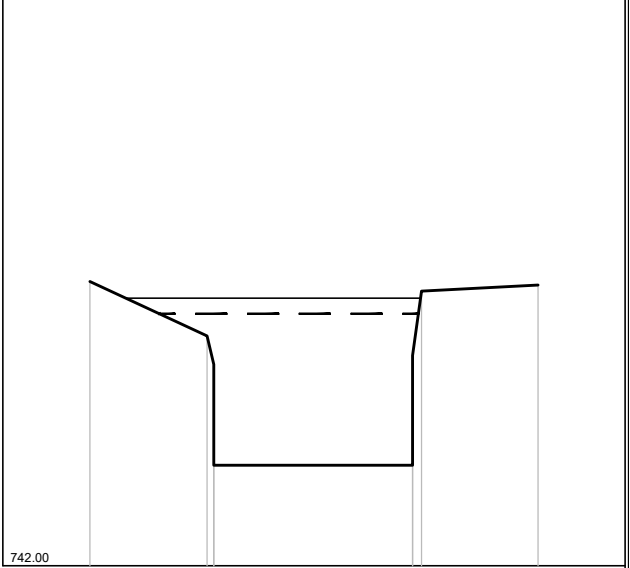

PUNTI	1	2	5	8
QUOTE [m s.l.m.]	745.76	745.04	743.33	745.71
DISTANZE PROGRESSIVE [m]	0.00	1.55	4.27	5.83
DISTANZE PARZIALI [m]		1.55	2.63	1.54

Fosso dell' Acquatorta  
 SEZIONE N° 00187PB21

LEGENDA:  
 TR030 H =745.31 m. s.l.m. ---  
 TR200 H =745.53 m. s.l.m. ———

SCALA DISTANZE 1:100  
 SCALA QUOTE 1:100

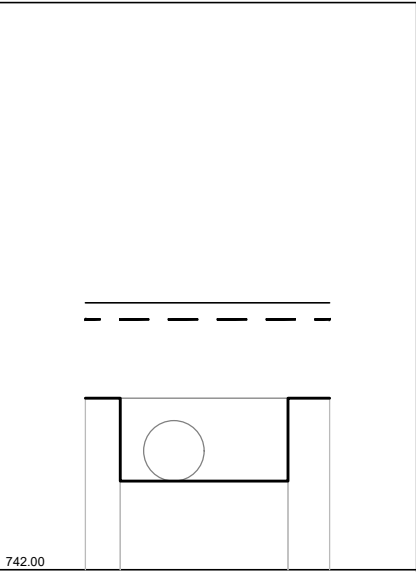

PUNTI	1	2	4	6
QUOTE [m s.l.m.]	744.27	744.27	743.17	744.27
DISTANZE PROGRESSIVE [m]	0.00	0.46	2.68	3.23
DISTANZE PARZIALI [m]			2.22	0.55

Fosso dell' Acquatorta  
 SEZIONE N° 00187PC21

LEGENDA:

TR030 H =743.74 m. s.l.m. 

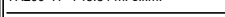
TR200 H =743.84 m. s.l.m. 

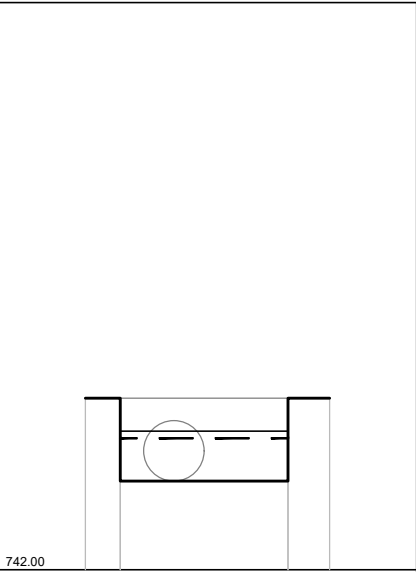

SCALA DISTANZE 1:100  
 SCALA QUOTE 1:100

PUNTI	1	2	4	6
QUOTE [m s.l.m.]	744.27	744.27	743.17	744.27
DISTANZE PROGRESSIVE [m]	0.00	0.46	2.68	3.23
DISTANZE PARZIALI [m]			2.22	0.55



Fosso dell' Acquatorta  
 SEZIONE N° 00182\_\_21

LEGENDA:

TR030 H = 734.67 m. s.l.m. 

TR200 H = 734.74 m. s.l.m. 

SCALA DISTANZE 1:100  
 SCALA QUOTE 1:100

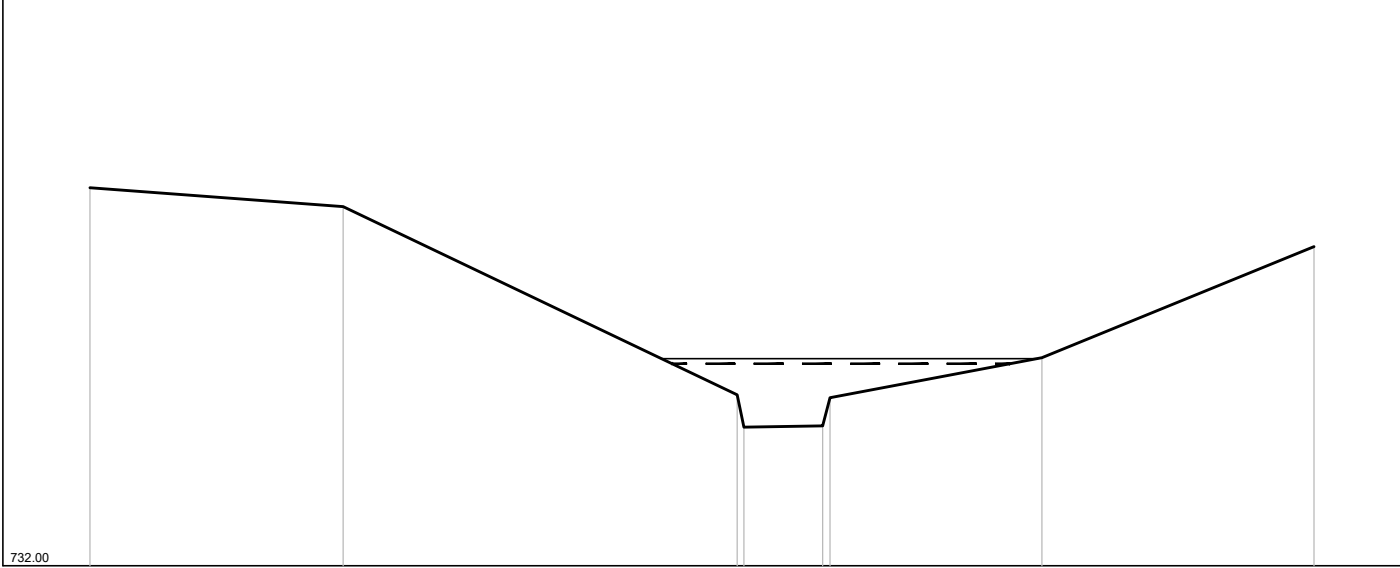

PUNTI	1	2	3	5	7	8
QUOTE [m s.l.m.]	737.00	736.75	734.26	733.85	734.75	736.22
DISTANZE PROGRESSIVE [m]	0.00	3.35	8.56	9.69	12.59	16.19
DISTANZE PARZIALI [m]		3.35	5.21	1.04	2.80	3.60

Fosso dell' Acquatorta  
 SEZIONE N° 00173\_\_21

LEGENDA:

TR030 H = 723.72 m. s.l.m.

TR200 H = 723.87 m. s.l.m.

SCALA DISTANZE 1:100  
 SCALA QUOTE 1:100

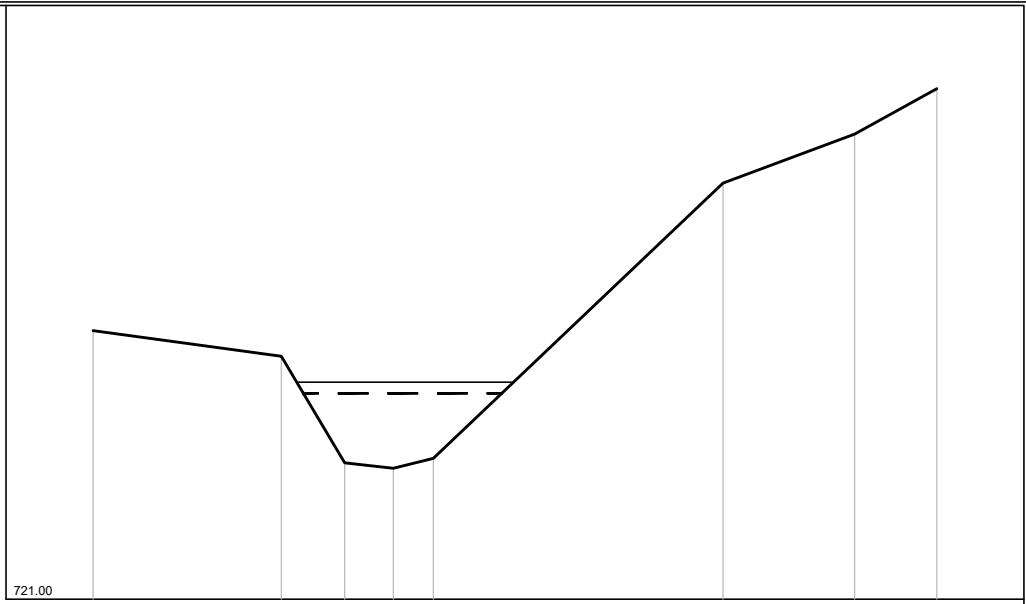

PUNTI	1	2	3	4	5	6	7	8
QUOTE [m s.l.m.]	724.55	724.21	722.80	722.73	722.86	726.50	727.15	727.75
DISTANZE PROGRESSIVE [m]	0.00	2.49	3.33	3.97	4.50	8.33	10.07	11.16
DISTANZE PARZIALI [m]		2.49	0.84	0.64	0.53	3.83	1.74	1.09

Fosso dell' Acquatorta  
 SEZIONE N° 00168PB21

LEGENDA:

TR030 H = 722.72 m. s.l.m. 

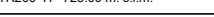
TR200 H = 723.00 m. s.l.m. 

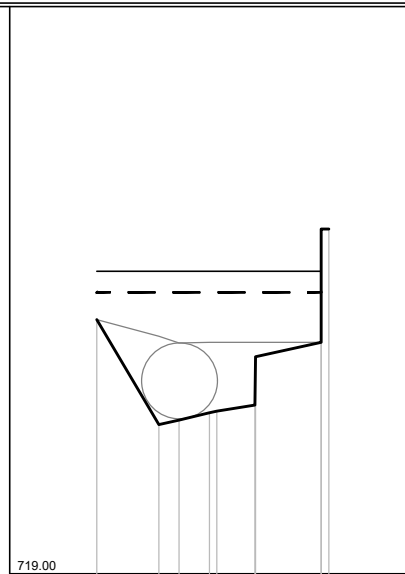

SCALA DISTANZE 1:100  
 SCALA QUOTE 1:100

PUNTI	1	2	3	4	6	8
QUOTE [m s.l.m.]	722.96	720.97	721.03	721.13	721.23	722.06
DISTANZE PROGRESSIVE [m]	0.00	0.82	1.09	1.49	2.09	2.97
DISTANZE PARZIALI [m]		0.82			0.50	0.87

Fosso dell' Acquatorta  
 SEZIONE N° 00168PC21

LEGENDA:

TR030 H = 715.25 m. s.l.m.

TR200 H = 715.37 m. s.l.m.

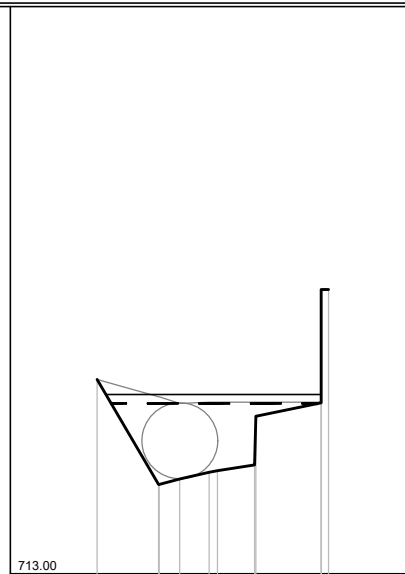

SCALA DISTANZE 1:100  
 SCALA QUOTE 1:100

PUNTI	1	2	4	5	7	9
QUOTE [m s.l.m.]	715.57	714.18	714.25	714.34	714.44	715.26
DISTANZE PROGRESSIVE [m]	0.00	0.81	1.09	1.48	2.08	2.96
DISTANZE PARZIALI [m]		0.81			0.49	0.86

Fosso dell' Acquatorta  
 SEZIONE N° 00150\_\_21

LEGENDA:

TR030 H =694.18 m. s.l.m. ---

TR200 H =694.32 m. s.l.m. ———

SCALA DISTANZE 1:100  
 SCALA QUOTE 1:100

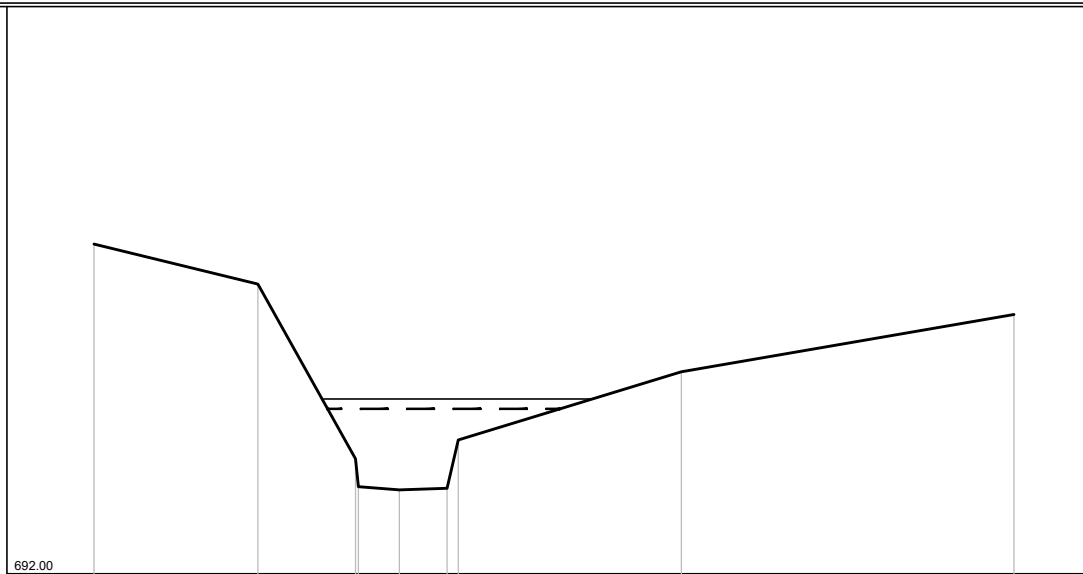

PUNTI	1	2	3	5	6	7	8	9
QUOTE [m s.l.m.]	696.38	695.83	693.52	693.11	693.13	693.77	694.67	695.43
DISTANZE PROGRESSIVE [m]	0.00	2.17	3.46	4.04	4.67	4.82	7.77	12.17
DISTANZE PARZIALI [m]		2.17	1.29	0.54	0.63		2.95	4.40

Fosso dell' Acquatorta  
 SEZIONE N° 00147\_\_21

LEGENDA:

TR030 H =689.77 m. s.l.m.   
 ---   
 TR200 H =690.27 m. s.l.m.   
 \_\_\_\_\_

SCALA DISTANZE 1:100  
 SCALA QUOTE 1:100

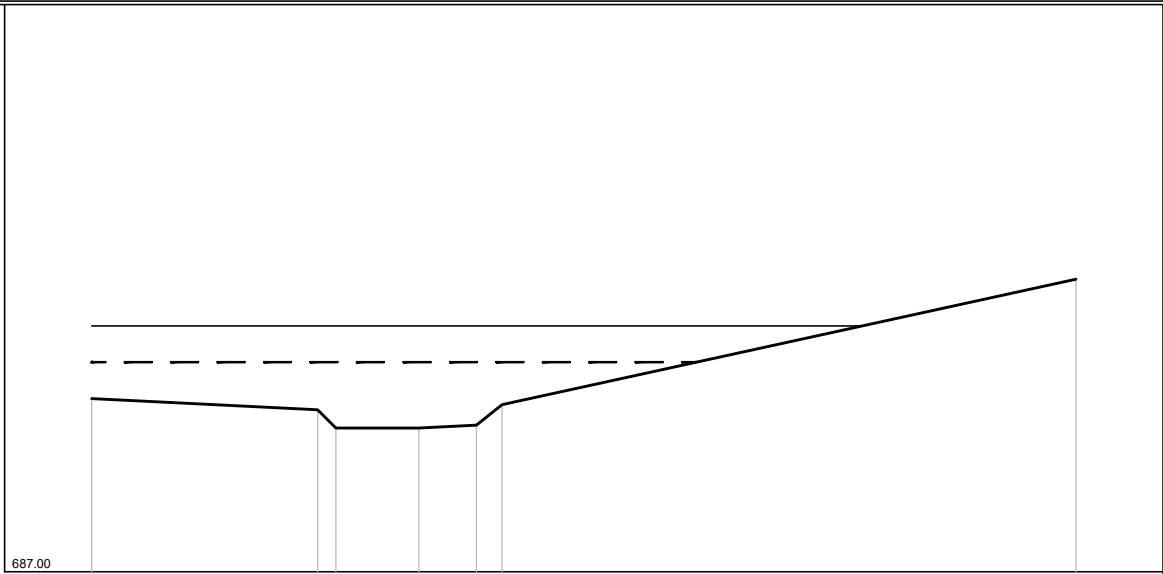

PUNTI	1	2	3	4	5	6	7
QUOTE [m s.l.m.]	689.29	689.14	688.90	688.90	688.94	689.21	690.87
DISTANZE PROGRESSIVE [m]	0.00	2.99	3.23	4.33	5.09	5.43	13.02
DISTANZE PARZIALI [m]		2.99		1.10	0.76		7.59

Fosso dell' Acquatorta  
 SEZIONE N° 00144\_\_21

LEGENDA:

TR030 H=685.41 m. s.l.m. 

TR200 H=685.68 m. s.l.m. 

SCALA DISTANZE 1:100  
 SCALA QUOTE 1:100

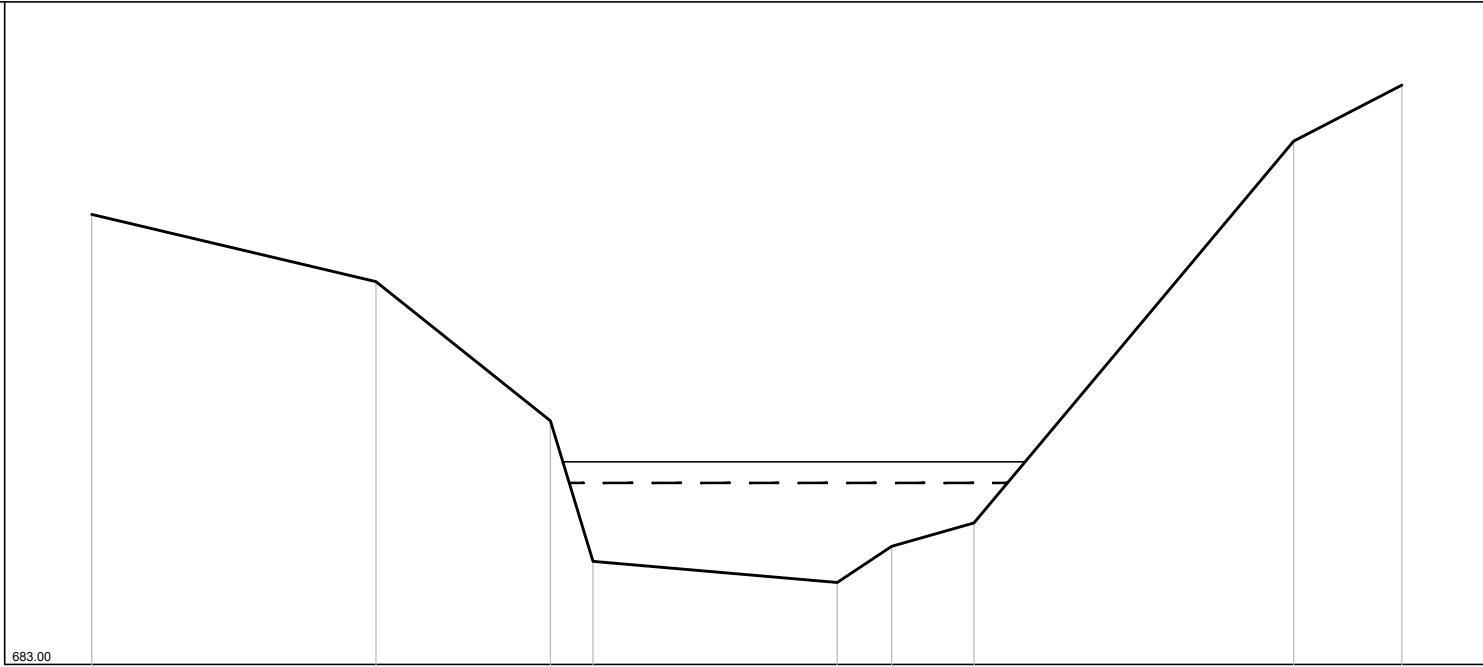

PUNTI	1	2	3	4	5	6	7	8	9
QUOTE [m s.l.m.]	688.95	688.06	686.22	684.36	684.08	684.56	684.87	689.92	690.66
DISTANZE PROGRESSIVE [m]	0.00	3.76	6.07	6.63	9.86	10.58	11.67	15.90	17.33
DISTANZE PARZIALI [m]		3.76	2.31	0.56	3.23	0.72	1.09	4.23	1.43

Fosso dell' Acquatorta  
 SEZIONE N° 00142\_\_21

LEGENDA:

TR030 H =684.54 m. s.l.m. ---

TR200 H =684.88 m. s.l.m. ———

SCALA DISTANZE 1:100  
 SCALA QUOTE 1:100

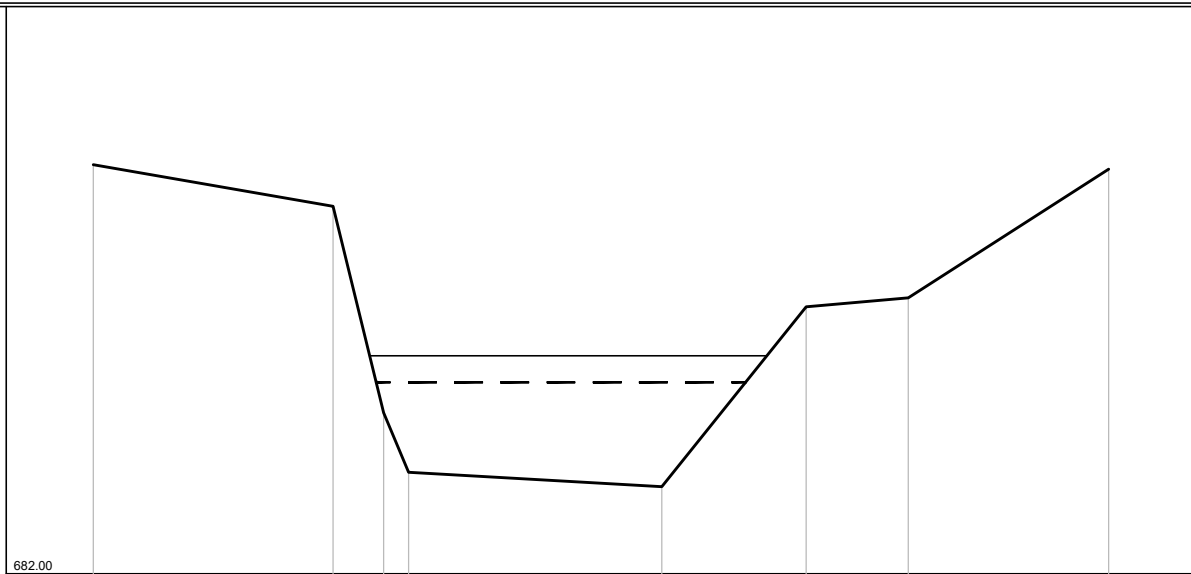

PUNTI	1	2	3	4	5	6	7	8
QUOTE [m s.l.m.]	687.41	686.86	684.13	683.34	683.15	685.53	685.65	687.35
DISTANZE PROGRESSIVE [m]	0.00	3.17	3.84	4.17	7.52	9.43	10.78	13.43
DISTANZE PARZIALI [m]		3.17	0.67		3.35	1.91	1.35	2.65



FOSSO DELL'ACQUATORTA - AFFLUENTE

Affluente Fosso Acquatorta  
 SEZIONE N° 00021PC21

LEGENDA:

TR030 H=702.99 m. s.l.m.

TR200 H=702.99 m. s.l.m.

SCALA DISTANZE 1:100  
 SCALA QUOTE 1:100

701.00

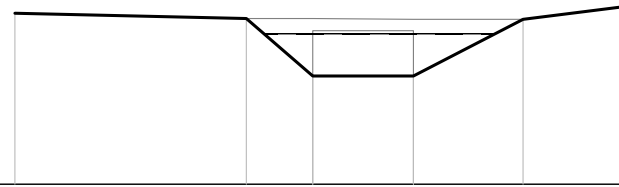

PUNTI	1	2	3	5	7	8
QUOTE [m s.l.m.]	703.26	703.19	702.43	702.43	703.16	703.35
DISTANZE PROGRESSIVE [m]	0.00	3.06	3.94	5.27	6.72	8.07
DISTANZE PARZIALI [m]		3.06	0.88	1.33	1.45	1.35

Affluente Fosso Acquatorta  
SEZIONE N° 00013\_\_21

LEGENDA:

TR030 H=701.03 m. s.l.m. — — —

TR200 H=701.03 m. s.l.m. — — —

SCALA DISTANZE 1:100  
SCALA QUOTE 1:100

699,00

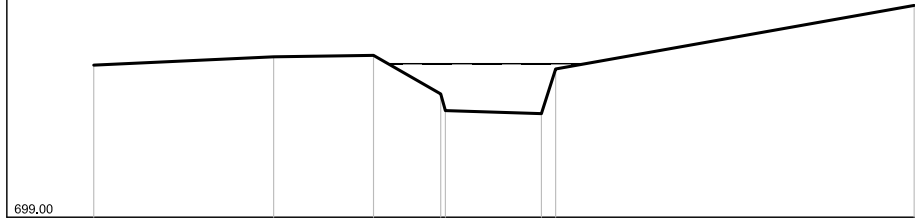

PUNTI	1	2	3	4	6	7	8
QUOTE [m s.l.m.]	701.01	701.12	701.14	700.63	700.37	700.96	701.80
DISTANZE PROGRESSIVE [m]	0.00	2.38	3.70	4.59	5.92	6.11	10.85
DISTANZE PARZIALI [m]		2.38	1.32	0.89	1.27		4.74

Affluente Fosso Acquatorta  
 SEZIONE N° 00006\_21

LEGENDA:

TR030 H = 696.54 m. s.l.m.

TR200 H = 696.55 m. s.l.m.

SCALA DISTANZE 1:100  
 SCALA QUOTE 1:100

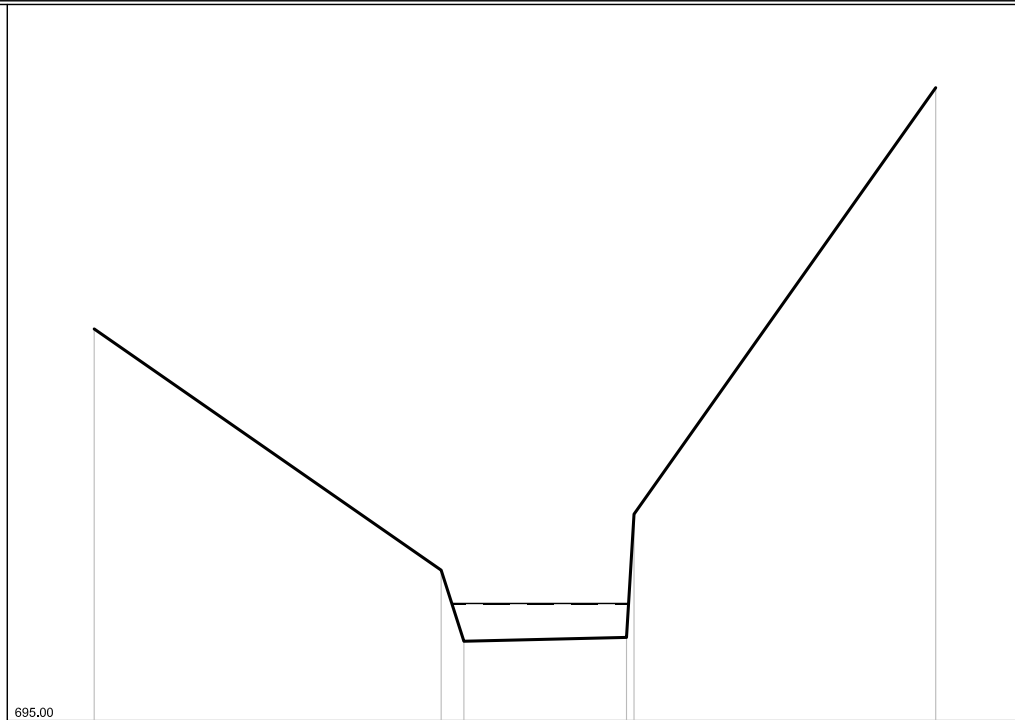

PUNTI	1	2	3	4	6
QUOTE [m s.l.m.]	700.18	696.99	696.05	696.10	703.37
DISTANZE PROGRESSIVE [m]	0.00	4.59	4.99	7.04	11.13
DISTANZE PARZIALI [m]		4.59		2.15	3.99

TORRENTE LE PRATA

Torrente Le Prata  
 SEZIONE N° 00043PB21

LEGENDA:

TR030 H = 724.11 m. s.l.m. 

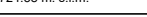
TR200 H = 724.38 m. s.l.m. 

SCALA DISTANZE 1:100  
 SCALA QUOTE 1:100

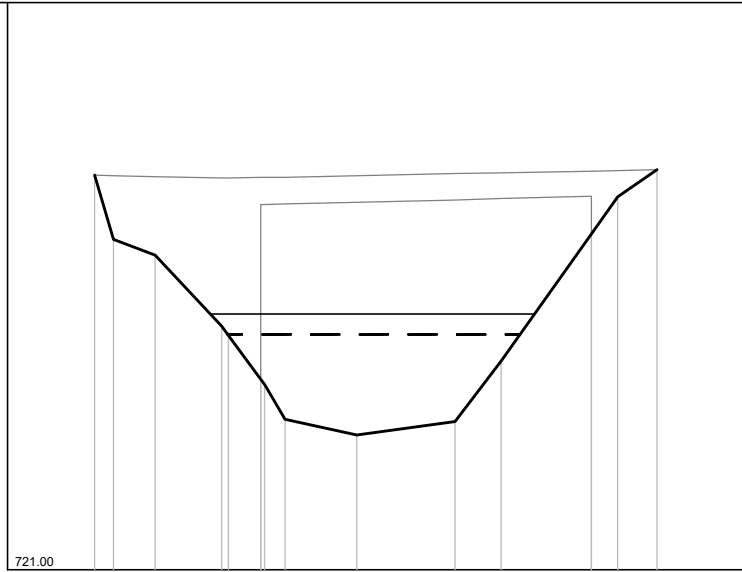

PUNTI	1	2	3	4	6	9	10	11	12	13	15	16
QUOTE [m s.l.m.]	726.22	725.37	725.16	724.22	723.52	722.89	722.78	722.96	723.76	725.44	725.83	726.29
DISTANZE PROGRESSIVE [m]	0.00	0.25	0.80	1.68	2.20	2.52	3.47	4.77	5.38	6.57	6.92	7.44
DISTANZE PARZIALI [m]		0.55	0.88			0.95	1.30	0.61	1.19		0.52	

Torrente Le Prata  
 SEZIONE N° 00043PC21

LEGENDA:

TR030 H = 723.48 m. s.l.m. 

TR200 H = 723.64 m. s.l.m. 

SCALA DISTANZE 1:100  
 SCALA QUOTE 1:100

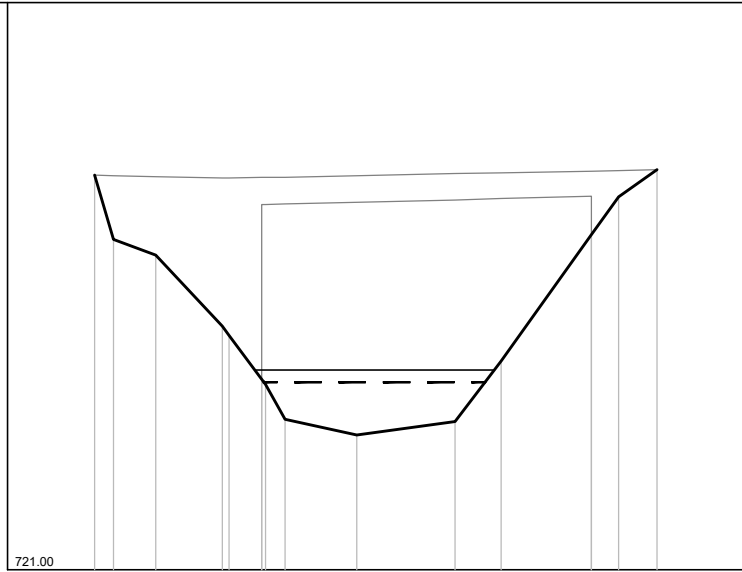

PUNTI	1	2	3	4	6	9	10	11	12	13	15	16
QUOTE [m s.l.m.]	726.22	725.37	725.16	724.22	723.52	722.89	722.78	722.96	723.76	725.43	725.83	726.29
DISTANZE PROGRESSIVE [m]	0.00	0.25	0.81	1.69	2.21	2.52	3.47	4.77	5.38	6.57	6.93	7.44
DISTANZE PARZIALI [m]		0.56	0.88			0.95	1.30	0.61	1.19		0.51	

Torrente Le Prata  
 SEZIONE N° 00041\_\_21

LEGENDA:

TR030 H = 721.39 m. s.l.m.

TR200 H = 721.54 m. s.l.m.

SCALA DISTANZE 1:100  
 SCALA QUOTE 1:100

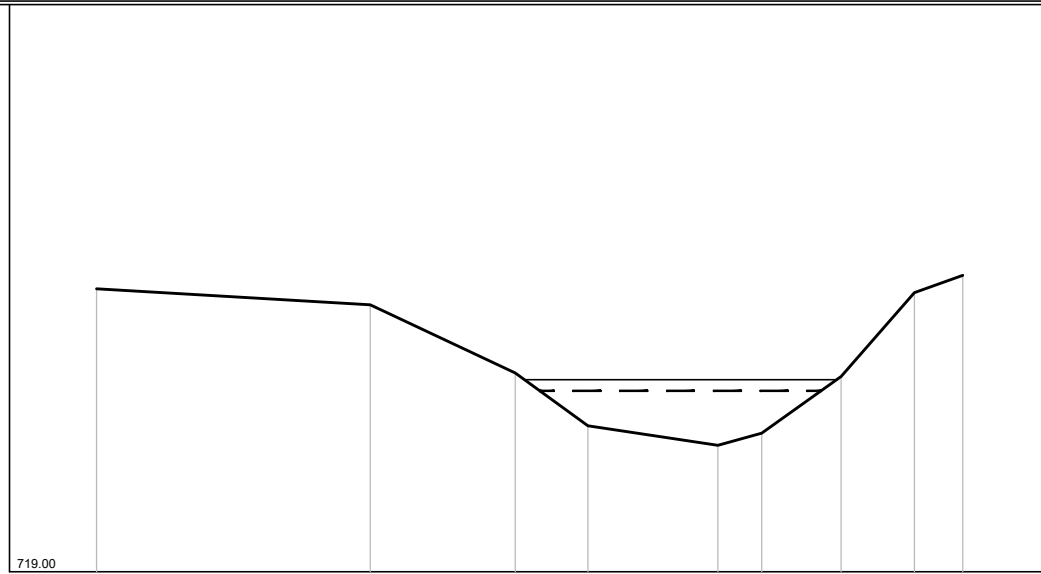

PUNTI	1	2	3	4	5	6	7	8	9
QUOTE [m s.l.m.]	722.74	722.53	721.63	720.93	720.67	720.83	721.58	722.89	722.92
DISTANZE PROGRESSIVE [m]	0.00	3.62	5.54	6.50	8.22	8.80	9.85	10.82	11.46
DISTANZE PARZIALI [m]		3.62	1.92	0.96	1.72	0.58	1.05	0.97	0.64



Torrente Le Prata  
 SEZIONE N° 00036BB21

LEGENDA:

TR030 H = 717.59 m. s.l.m. 

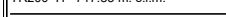
TR200 H = 717.85 m. s.l.m. 

SCALA DISTANZE 1:100  
 SCALA QUOTE 1:100

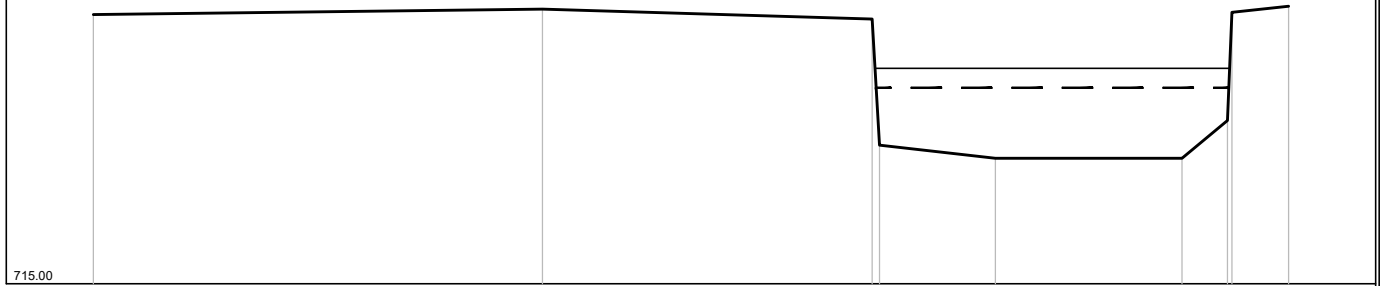

PUNTI	1	2	3	5	6	7	9
QUOTE [m s.l.m.]	718.56	718.63	718.50	716.66	716.66	717.16	718.67
DISTANZE PROGRESSIVE [m]	0.00	5.94	10.30	11.93	14.40	15.00	15.81
DISTANZE PARZIALI [m]		5.94	4.36	1.53	2.47	0.60	0.75

Torrente Le Prata  
 SEZIONE N° 00036BC21

LEGENDA:

TR030 H = 715.04 m. s.l.m. - - - - -

TR200 H = 715.28 m. s.l.m. \_\_\_\_\_

SCALA DISTANZE 1:100  
 SCALA QUOTE 1:100

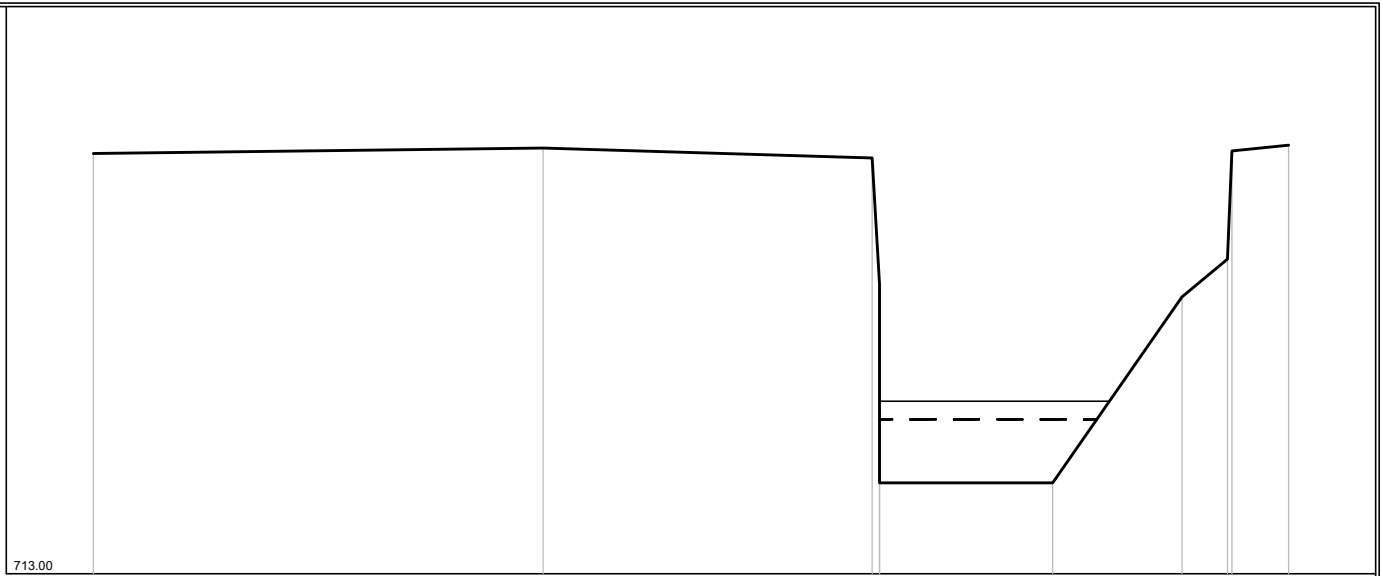

PUNTI	1	2	3	6	7	8	10
QUOTE [m s.l.m.]	718.56	718.63	718.50	714.20	716.66	717.16	718.67
DISTANZE PROGRESSIVE [m]	0.00	5.95	10.30	12.69	14.40	15.00	15.81
DISTANZE PARZIALI [m]		5.95	4.35	2.29	1.71	0.60	0.75

Torrente Le Prata  
 SEZIONE N° 00032\_\_21

LEGENDA:

TR030 H = 713.00 m. s.l.m.

TR200 H = 713.24 m. s.l.m.

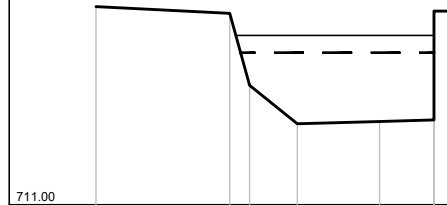

SCALA DISTANZE 1:100  
 SCALA QUOTE 1:100

PUNTI	1	2	3	4	5	6	8
QUOTE [m s.l.m.]	713.62	713.53	712.58	712.07	712.10	712.12	713.56
DISTANZE PROGRESSIVE [m]	0.00	1.77	2.03	2.66	3.75	4.47	4.67
DISTANZE PARZIALI [m]		1.77	0.63	1.09	0.72		

Torrente Le Prata  
 SEZIONE N° 00030PB21

LEGENDA:

TR030 H = 712.77 m. s.l.m.

TR200 H = 712.96 m. s.l.m.

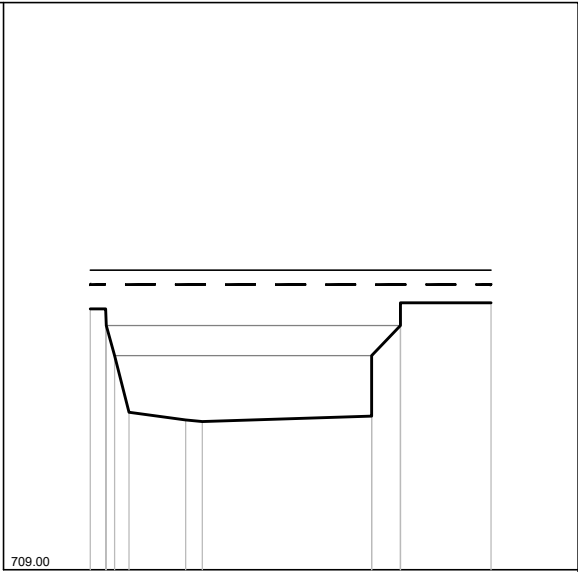

SCALA DISTANZE 1:100  
 SCALA QUOTE 1:100

PUNTI	1	2	4	5	6	7	8	10	12
QUOTE [m s.l.m.]	712.45	712.45	711.83	711.08	710.98	710.96	711.03	712.23	712.53
DISTANZE PROGRESSIVE [m]	0.00	0.30	0.32	0.51	1.26	1.48	3.72	4.10	5.30
DISTANZE PARZIALI [m]					0.75		2.24		1.20

Torrente Le Prata  
 SEZIONE N° 00030PC21

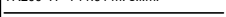
LEGENDA:  
 TR030 H = 711.78 m. s.l.m.   
 TR200 H = 711.91 m. s.l.m. 

SCALA DISTANZE 1:100  
 SCALA QUOTE 1:100

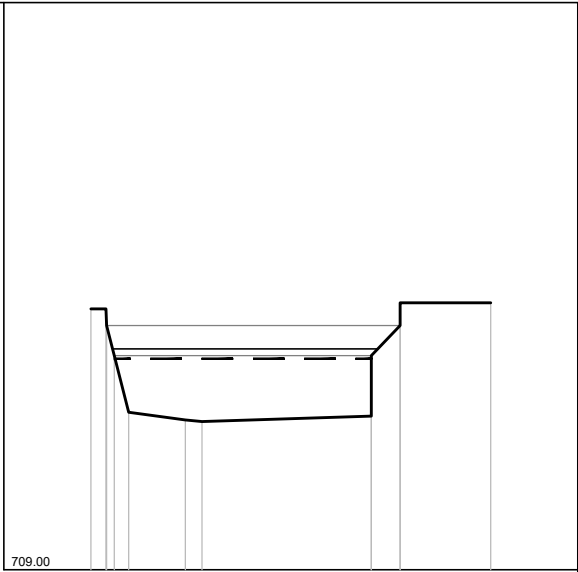

PUNTI	1	2	5	6	7	8	10	12
QUOTE [m s.l.m.]	712.45	712.45	711.08	710.98	710.96	711.03	712.23	712.53
DISTANZE PROGRESSIVE [m]	0.00	0.20	0.50	1.25	1.47	3.71	4.09	5.29
DISTANZE PARZIALI [m]			0.75			2.24		1.20

Torrente Le Prata  
 SEZIONE N° 00024PB21

LEGENDA:

TR030 H = 707.91 m. s.l.m.

TR200 H = 708.13 m. s.l.m.

SCALA DISTANZE 1:100  
 SCALA QUOTE 1:100

705.00

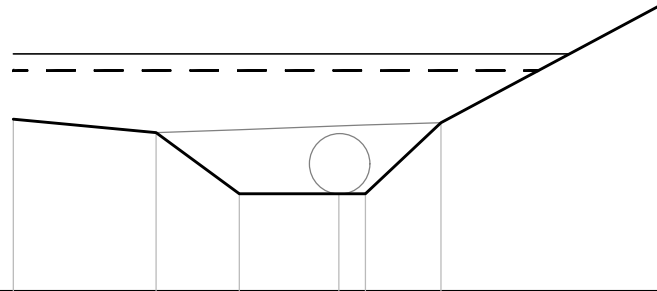

PUNTI	1	2	3	4	5	6	7
QUOTE [m s.l.m.]	707.27	707.09	706.28	706.28	706.28	707.22	708.76
DISTANZE PROGRESSIVE [m]	0.00	1.89	2.99	4.31	4.66	5.66	8.53
DISTANZE PARZIALI [m]		1.89	1.10	1.32		1.00	2.87

Torrente Le Prata  
 SEZIONE N° 00024PC21

LEGENDA:

TR030 H = 706.95 m. s.l.m.

TR200 H = 707.07 m. s.l.m.

SCALA DISTANZE 1:100  
 SCALA QUOTE 1:100

705.00

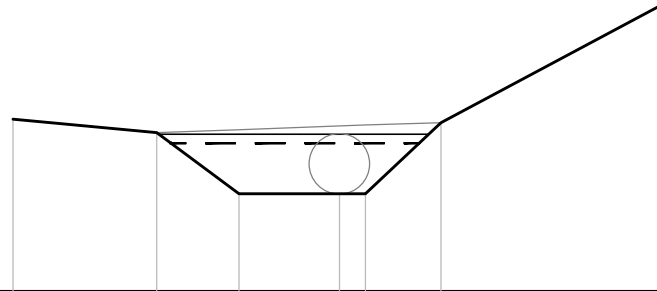

PUNTI	1	2	3	4	5	6	7
QUOTE [m s.l.m.]	707.27	707.09	706.28	706.28	706.28	707.22	708.76
DISTANZE PROGRESSIVE [m]	0.00	1.90	2.99	4.32	4.66	5.66	8.54
DISTANZE PARZIALI [m]		1.90	1.09	1.33		1.00	2.88

Torrente Le Prata  
 SEZIONE N° 00022\_\_21

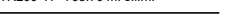
LEGENDA:  
 TR030 H = 705.58 m. s.l.m.   
 TR200 H = 705.70 m. s.l.m. 

SCALA DISTANZE 1:100  
 SCALA QUOTE 1:100

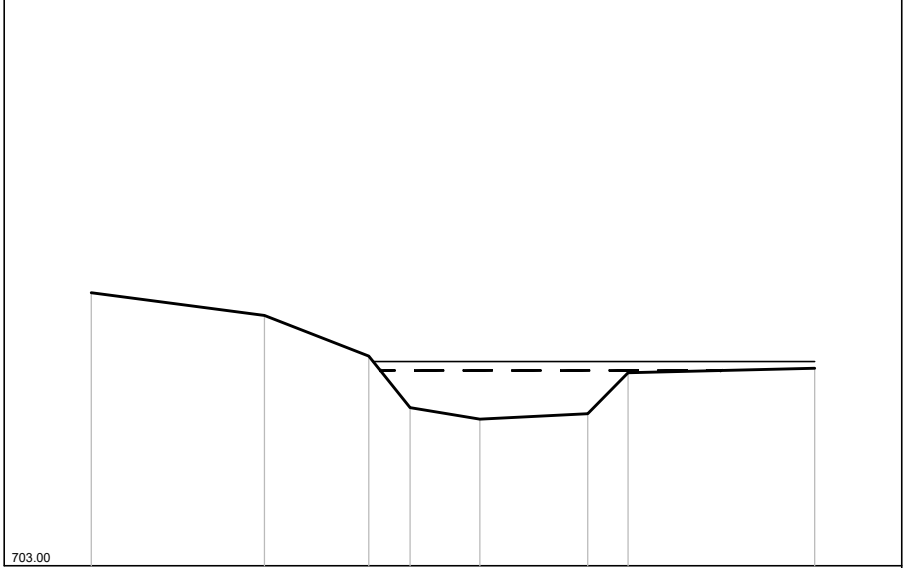



PUNTI	1	2	3	4	5	6	7	8
QUOTE [m s.l.m.]	706.61	706.31	705.77	705.09	704.94	705.01	705.55	705.61
DISTANZE PROGRESSIVE [m]	0.00	2.29	3.67	4.22	5.14	6.57	7.10	9.57
DISTANZE PARZIALI [m]		2.29	1.38	0.55	0.92	1.43	0.53	2.47



Torrente Le Prata  
 SEZIONE N° 00016\_\_21

LEGENDA:

TR030 H = 701.65 m. s.l.m. 

TR200 H = 701.81 m. s.l.m. 

SCALA DISTANZE 1:100  
 SCALA QUOTE 1:100

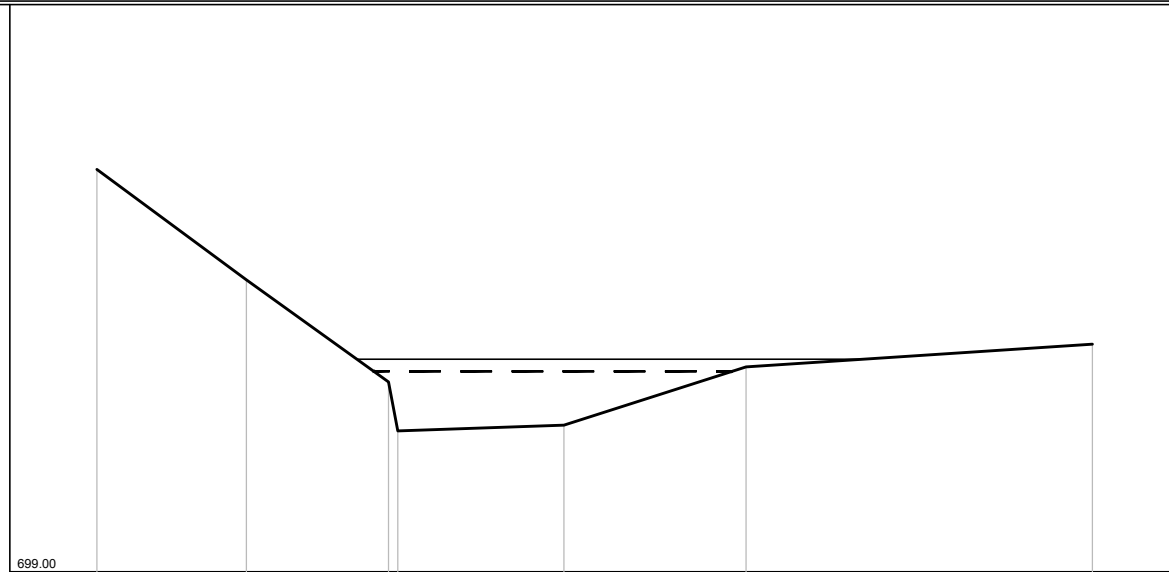

PUNTI	1	2	3	5	6	7
QUOTE [m s.l.m.]	704.32	702.86	701.51	700.94	701.71	702.01
DISTANZE PROGRESSIVE [m]	0.00	1.98	3.86	6.18	8.59	13.17
DISTANZE PARZIALI [m]		1.98	1.88	2.20	2.41	4.58

Torrente Le Prata  
 SEZIONE N° 00013\_\_21

LEGENDA:

TR030 H = 700.30 m. s.l.m.

TR200 H = 700.47 m. s.l.m.

SCALA DISTANZE 1:100  
 SCALA QUOTE 1:100

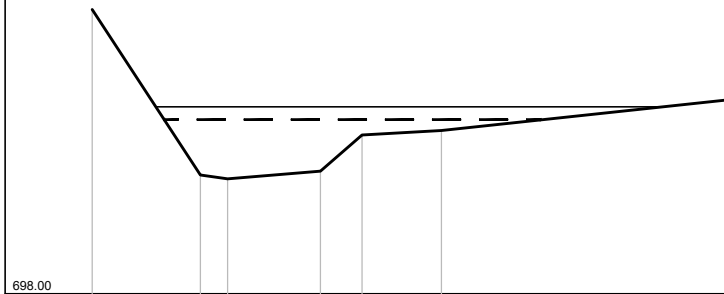

PUNTI	1	2	3	4	5	6	7
QUOTE [m s.l.m.]	701.76	699.57	699.52	699.62	700.10	700.16	700.57
DISTANZE PROGRESSIVE [m]	0.00	1.43	1.79	3.02	3.57	4.62	8.46
DISTANZE PARZIALI [m]		1.43	1.23	0.55	1.05	3.84	

Torrente Le Prata  
SEZIONE N° 00002\_21

LEGENDA:

TR030 H = 690.50 m. s.l.m. - - - - -

TR200 H = 690.81 m. s.l.m. \_\_\_\_\_

SCALA DISTANZE 1:100  
SCALA QUOTE 1:100

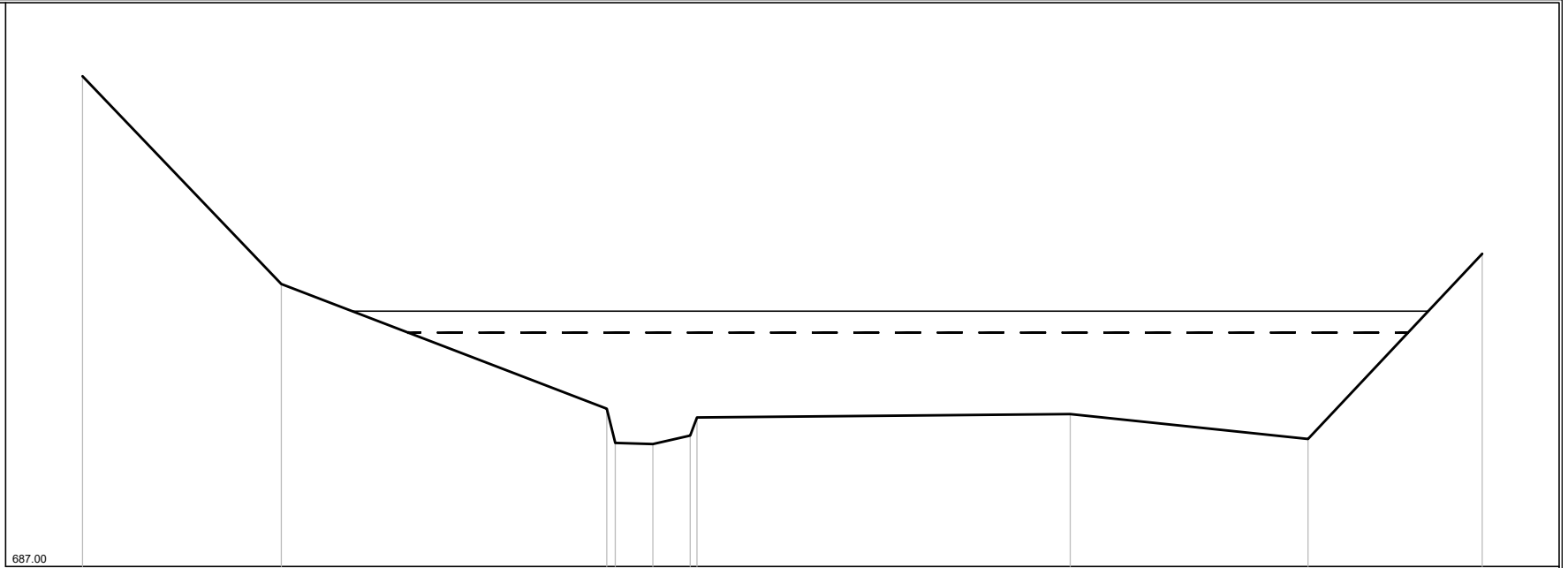

PUNTI	1	2	3	4	5	6	7	8	9	10
QUOTE [m s.l.m.]	694.34	691.23	688.26	688.53	688.53	688.96		689.28	688.91	691.68
DISTANZE PROGRESSIVE [m]	0.00	2.98	7.98	8.54	9.10			14.79	18.35	20.96
DISTANZE PARZIALI [m]		2.98	4.87	0.56	0.56			5.59	3.56	2.61